

Artikelnummer RST <i>Article Code RST</i>	Herstellernummer <i>Manufacturer Code</i>	Größe <i>Size</i>	Gewinde <i>Entry Thread</i>	D <i>(mm)</i>	D i <i>(mm)</i>	D 1 <i>(mm)</i>	L <i>(mm)</i>	H <i>(mm)</i>	VPE * <i>PU *</i>
MPC90-40-M40B	MPC90-40-M40B	40	M40x1.5	60.0	33.0	50.0	16.0	97.0	2

Material	Polyamid 66
Einsatztemperatur	-40°C bis +120°C
Schutzart gem. IEC 60529	IP66/IP68 (Schlauch berücksichtigen)
CE-Kennzeichnung	ja (Richtlinie 2014/35/EU)
Zolltarif-Nummer	39269097
Gewicht	0.215 kg
EAN-Nummer	
RoHS (2015/863/EU)	konform
REACH/SVHC (Art. 33 1907/2006)	keine SVHC-Stoffe enthalten
Konfliktminerale (Dodd-Frank Act)	keine Konfliktminerale enthalten

<i>Material</i>	<i>Polyamide 66</i>
<i>Operating Temperature</i>	<i>-40°C to +120°C</i>
<i>Protection Class rel. IEC 60529</i>	<i>IP66/IP68 (consider conduit)</i>
<i>CE Marking</i>	<i>yes (Directive 2014/35/EU)</i>
<i>Customs Tariff Number</i>	<i>39269097</i>
<i>Weight</i>	<i>0.215 kg</i>
<i>EAN Code</i>	
<i>RoHS (2015/863/EU)</i>	<i>compliant</i>
<i>REACH/SVHC (Art. 33 1907/2006)</i>	<i>contain no SVHC substances</i>
<i>Konfliktminerale (Dodd-Frank Act)</i>	<i>contain no conflict minerals</i>

Für besondere Bedingungen oder Einschränkungen siehe entsprechende Produktdokumentation.

For specific conditions or limitations please see relevant product documentation.

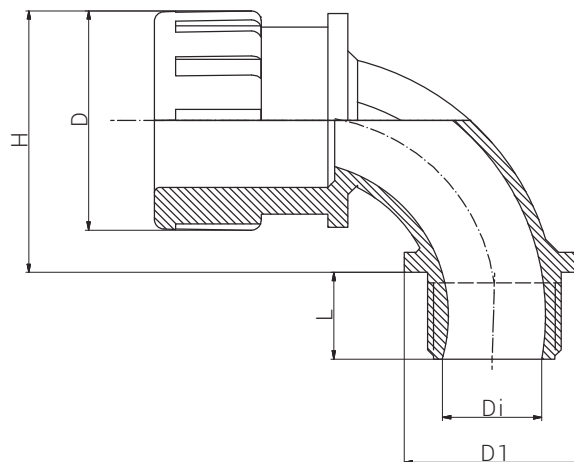

## Schutzschlauchsysteme Conduit Systems MPC 90° / M



## Produktdokumentation Product Documentation



\* Mindestbestellmenge (MOQ) kann größer sein als Verpackungseinheit (VPE).

\* Minimum order quantity (MOQ) can be larger than packaging unit (PU).

**RST Rabe-System-Technik und Vertriebs-GmbH**  
Otto-Lilienthal-Strasse 19  
49134 Wallenhorst

DEUTSCHLAND

+49 5407 8766-0

+49 5407 8766-99

info@rst.eu

www.rst.eu