

Artikelnummer RST Article Code RST	Herstellernummer Manufacturer Code	Größe Size	Gewinde Entry Thread	D (mm)	D i (mm)	D 1 (mm)	L (mm)	H (mm)	VPE * PU *
MPC90-20-M20B	MPC90-20-M20B	20	M20x1.5	33.0	14.5	27.0	13.0	39.0	10

Material	Polyamid 66
Einsatztemperatur	-40°C bis +120°C
Schutzart gem. IEC 60529	IP66/IP68 (Schlauch berücksichtigen)
CE-Kennzeichnung	ja (Richtlinie 2014/35/EU)
Zolltarif-Nummer	39269097
Gewicht	0.194 kg
EAN-Nummer	
RoHS (2015/863/EU)	konform
REACH/SVHC (Art. 33 1907/2006)	keine SVHC-Stoffe enthalten
Konfliktminerale (Dodd-Frank Act)	keine Konfliktminerale enthalten

Material	Polyamide 66
Operating Temperature	-40°C to +120°C
Protection Class rel. IEC 60529	IP66/IP68 (consider conduit)
CE Marking	yes (Directive 2014/35/EU)
Customs Tariff Number	39269097
Weight	0.194 kg
EAN Code	
RoHS (2015/863/EU)	compliant
REACH/SVHC (Art. 33 1907/2006)	contain no SVHC substances
Konfliktminerale (Dodd-Frank Act)	contain no conflict minerals

Für besondere Bedingungen oder Einschränkungen siehe entsprechende Produktdokumentation.

For specific conditions or limitations please see relevant product documentation.

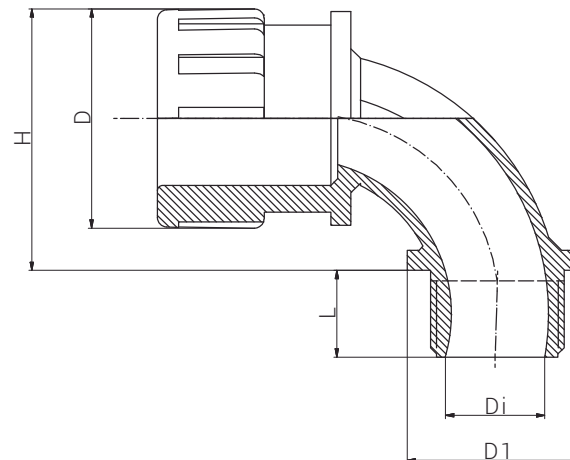

## Schutzschlauchsysteme Conduit Systems MPC 90° / M



## Produktdokumentation Product Documentation



\* Mindestbestellmenge (MOQ) kann größer sein als Verpackungseinheit (VPE).

\* Minimum order quantity (MOQ) can be larger than packaging unit (PU).

**RST Rabe-System-Technik und Vertriebs-GmbH**  
Otto-Lilienthal-Strasse 19  
49134 Wallenhorst

DEUTSCHLAND

+49 5407 8766-0

+49 5407 8766-99

info@rst.eu

www.rst.eu