

Artikelnummer RST Article Code RST	Herstellernummer Manufacturer Code	Größe Size	Gewinde Entry Thread		D (mm)	Di (mm)	D1 (mm)	L (mm)	H (mm)	VPE * PU *
FPAU16-M20-90B	FPAU16-M20-90B	21	M20x1.5	30.0	32.0	14.0	27.0	14.0	40.0	10

Material	Polyamid 66
Dichteinsatz	Polyester
Flachdichtung	Polyester
Einsatztemperatur	-50°C bis +135°C
Schutzart gem. IEC 60529	IP66/IP68/IP69
CE-Kennzeichnung	ja (Richtlinie 2014/35/EU)
Zolltarif-Nummer	39269097
Gewicht	0.186 kg
RoHS (2015/863/EU)	konform
REACH/SVHC (Art. 33 1907/2006)	keine SVHC-Stoffe enthalten
Konfliktminerale (Dodd-Frank Act)	keine Konfliktminerale enthalten

Material	Polyamide 66
Sealing	Polyester
Flat Sealing Washer	Polyester
Operating Temperature	-50°C to +135°C
Protection Class rel. IEC 60529	IP66/IP68/IP69
CE Marking	yes (Directive 2014/35/EU)
Customs Tariff Number	39269097
Weight	0.186 kg
RoHS (2015/863/EU)	compliant
REACH/SVHC (Art. 33 1907/2006)	contain no SVHC substances
Konfliktminerale (Dodd-Frank Act)	contain no conflict minerals

Für besondere Bedingungen oder Einschränkungen siehe entsprechende Produktdokumentation.

For specific conditions or limitations please see relevant product documentation.

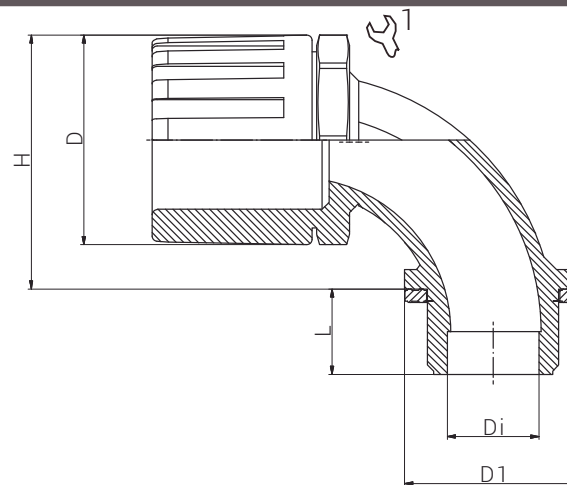

Schutzschlauchsysteme Conduit Systems ULTRA 90° / M



Produktdokumentation Product Documentation



* Mindestbestellmenge (MOQ) kann größer sein als Verpackungseinheit (VPE).

* Minimum order quantity (MOQ) can be larger than packaging unit (PU).

RST Rabe-System-Technik und Vertriebs-GmbH
Otto-Lilienthal-Strasse 19
49134 Wallenhorst

DEUTSCHLAND

+49 5407 8766-0

+49 5407 8766-99

info@rst.eu

www.rst.eu