

Artikelnummer RST <i>Article Code RST</i>	Herstellernummer <i>Manufacturer Code</i>	Größe <i>Size</i>	Gewinde <i>Entry Thread</i>		D (mm)	D i (mm)	D1 (mm)	L (mm)	H (mm)	VPE * <i>PU *</i>
FPA16-M16-90B	FPA16-M16-90B	16	M16x1.5	22.0	29.0	10.5	22.0	11.0	38.0	10

Material	Polyamid 66
Einsatztemperatur	-50°C bis +135°C
Schutzart gem. IEC 60529	IP66
CE-Kennzeichnung	ja (Richtlinie 2014/35/EU)
Zolltarif-Nummer	39269097
Gewicht	0.014 kg
EAN-Nummer	4054838013301
RoHS (2015/863/EU)	konform
REACH/SVHC (Art. 33 1907/2006)	keine SVHC-Stoffe enthalten
Konfliktmineralien (Dodd-Frank Act)	keine Konfliktmineralien enthalten

<i>Material</i>	<i>Polyamide 66</i>
<i>Operating Temperature</i>	<i>-50°C to +135°C</i>
<i>Protection Class rel. IEC 60529</i>	<i>IP66</i>
<i>CE Marking</i>	<i>yes (Directive 2014/35/EU)</i>
<i>Customs Tariff Number</i>	<i>39269097</i>
<i>Weight</i>	<i>0.014 kg</i>
<i>EAN Code</i>	<i>4054838013301</i>
<i>RoHS (2015/863/EU)</i>	<i>compliant</i>
<i>REACH/SVHC (Art. 33 1907/2006)</i>	<i>contain no SVHC substances</i>
<i>Konfliktmineralien (Dodd-Frank Act)</i>	<i>contain no conflict minerals</i>

Für besondere Bedingungen oder Einschränkungen siehe entsprechende Produktdokumentation.

For specific conditions or limitations please see relevant product documentation.

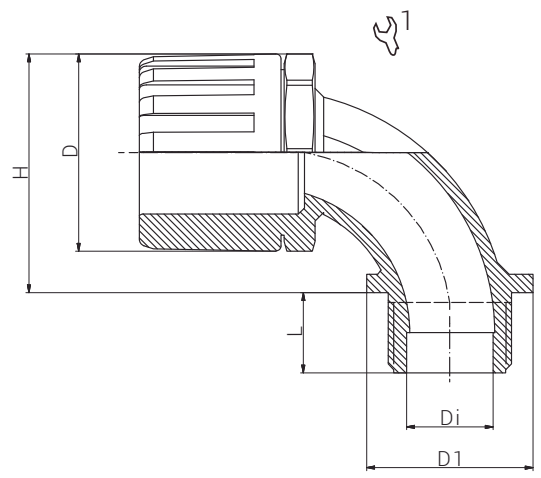

Schutzschlauchsysteme Conduit Systems FPA 90° / M



Produktdokumentation Product Documentation



* Mindestbestellmenge (MOQ) kann größer sein als Verpackungseinheit (VPE).
* Minimum order quantity (MOQ) can be larger than packaging unit (PU).

RST Rabe-System-Technik und Vertriebs-GmbH
Otto-Lilienthal-Strasse 19
49134 Wallenhorst

DEUTSCHLAND

+49 5407 8766-0
+49 5407 8766-99
info@rst.eu
www.rst.eu